

# EC11 Series

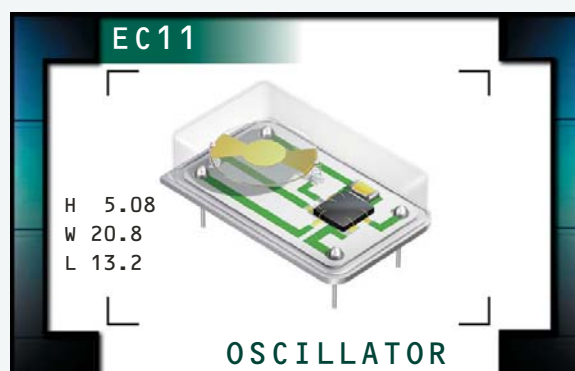

ECLIPTEK<sup>®</sup>  
CORPORATION

- RoHS Compliant (Pb-free)
- HCMOS/TTL output
- 5.0V supply voltage
- 14 pin DIP package
- Stability to  $\pm 20$ ppm
- Custom lead length, gull wing options available



## ELECTRICAL SPECIFICATIONS

<b>Frequency Range (MHz)</b>		0.250MHz to 106.250MHz
<b>Operating Temperature Range</b>		0°C to 70°C or -40°C to 85°C
<b>Storage Temperature Range</b>		-55°C to 125°C
<b>Supply Voltage (<math>V_{DD}</math>)</b>		5.0V <sub>DC</sub> $\pm 10\%$
<b>Input Current</b>	250.000kHz to 24.000MHz	45mA Maximum
	24.001MHz to 50.000MHz	55mA Maximum
	50.001MHz to 66.667MHz	65mA Maximum
	66.668MHz to 106.250MHz	85mA Maximum
<b>Frequency Tolerance / Stability</b>	Inclusive of Operating Temperature Range, Supply Voltage, and Load	$\pm 100$ ppm, $\pm 50$ ppm, $\pm 25$ ppm, or $\pm 20$ ppm Max. (0°C to 70°C Only)
<b>Output Voltage Logic High (<math>V_{OH}</math>)</b>	w/TTL Load	2.4V <sub>DC</sub> Minimum
	w/HCMOS Load	$V_{DD} - 0.5V_{DC}$ Minimum
<b>Output Voltage Logic Low (<math>V_{OL}</math>)</b>	w/TTL Load	0.4V <sub>DC</sub> Maximum
	w/HCMOS Load	0.5V <sub>DC</sub> Maximum
<b>Rise Time / Fall Time</b>	0.4V <sub>DC</sub> to 2.4V <sub>DC</sub> w/TTL Load; 20% to 80% of Waveform w/HCMOS Load	6 nSeconds Maximum
<b>Duty Cycle</b>	at 1.4V <sub>DC</sub> w/TTL Load; at 50% of Waveform w/HCMOS Load	50 $\pm 10$ (%) (Standard)
	at 1.4V <sub>DC</sub> w/TTL Load or w/HCMOS Load $\leq 70.000$ MHz	50 $\pm 5$ (%) (Optional)
	at 50% of Waveform w/TTL Load or w/HCMOS Load $> 70.000$ MHz	50 $\pm 5$ (%) (Optional)
<b>Load Drive Capability</b>	250.000kHz to 24.000MHz	10TTL Load or 50pF HCMOS Load
	24.001MHz to 70.000MHz	10TTL Load or 15pF HCMOS Load
	70.001MHz to 106.250MHz	10LSTTL Load or 15pF HCMOS Load
<b>Tri-State Input Voltage</b>	$V_{IH}$ : No Connection	Enables Output
	$V_{IH}$ : $\geq 2.2V_{DC}$	Enables Output
	$V_{IL}$ : $\leq 0.8V_{DC}$	Disables Output: High Impedance
<b>Aging (at 25°C)</b>		$\pm 5$ ppm / year Maximum
<b>Start Up Time</b>		10mSeconds Maximum
<b>Period Jitter: Absolute</b>		$\pm 100$ pSeconds Maximum
<b>Period Jitter: One Sigma</b>		$\pm 25$ pSeconds Maximum

MANUFACTURER  
ECLIPTEK CORP.

CATEGORY  
OSCILLATOR

SERIES  
EC11

PACKAGE  
14 pin DIP

VOLTAGE  
5.0V

CLASS  
OS04

REV. DATE  
08/06

## PART NUMBERING GUIDE

**EC11 00 ETTTS - 60.000M - G**

### FREQUENCY TOLERANCE / STABILITY

00=±100ppm Max. (Standard), 45=±50ppm Max.  
25=±25ppm Max., 20=±20ppm Max.

### OPERATING TEMP. RANGE

Blank=0°C to 70°C (Standard), ET=-40°C to 85°C

### DUTY CYCLE

Blank=50 ±10% (Standard), T=50 ±5%

### AVAILABLE OPTIONS

Blank=None (Standard)  
CLXXX=Custom Lead Length (See Page 133)  
G=Full Size Gull Wing (See Page 132)

### FREQUENCY

K=kHz, M=MHz

### OUTPUT CONTROL FUNCTION

Blank=None (No Connection on Pin 1)  
TS=Tri-State Enable High

## NOTES

www.DataSheet4U.com

### MECHANICAL DIMENSIONS

ALL DIMENSIONS IN MILLIMETERS

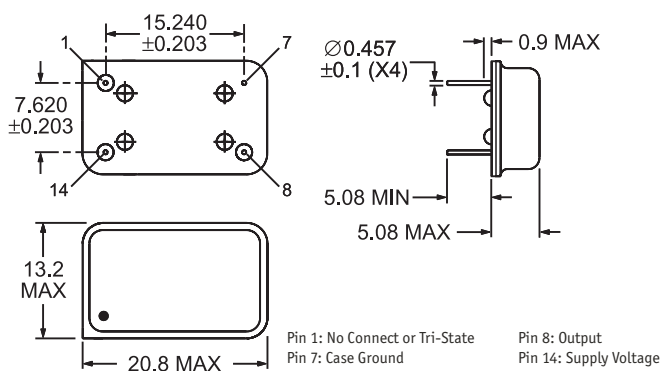

### MARKING SPECIFICATIONS

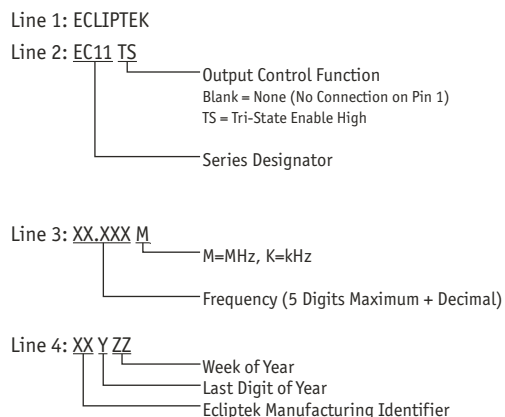

Note: Pin 1 shall be designated with a dot

### ENVIRONMENTAL/MECHANICAL SPECIFICATIONS

Characteristic	Specification
Fine Leak Test	MIL-STD-883, Method 1014, Condition A
Gross Leak Test	MIL-STD-883, Method 1014, Condition C
Mechanical Shock	MIL-STD-202, Method 213, Condition C
Vibration	MIL-STD-883, Method 2007, Condition A
Lead Integrity	MIL-STD-883, Method 2004

Characteristic	Specification
Solderability	MIL-STD-883, Method 2002
Temperature Cycling	MIL-STD-883, Method 1010
Resistance to Soldering Heat	MIL-STD-883, Method 210
Resistance to Solvents	MIL-STD-883, Method 215

MANUFACTURER	CATEGORY	SERIES	PACKAGE	VOLTAGE	CLASS	REV. DATE
ECLIPTEK CORP.	OSCILLATOR	EC11	14 pin DIP	5.0V	OS04	08/06

# EC11 Series

- RoHS Compliant (Pb-free)
- HCMOS/TTL output
- 5.0V supply voltage
- 8 pin DIP package
- Stability to  $\pm 20$ ppm
- Custom lead length, gull wing options available



ECLIPTEK<sup>®</sup>  
CORPORATION

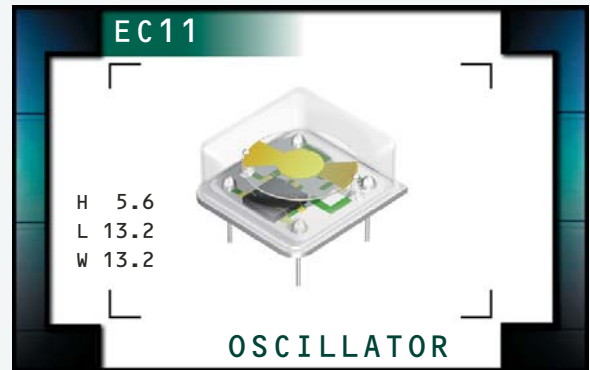

## ELECTRICAL SPECIFICATIONS

<b>Frequency Range (MHz)</b>		0.250MHz to 106.250MHz
<b>Operating Temperature Range</b>		0°C to 70°C or -40°C to 85°C
<b>Storage Temperature Range</b>		-55°C to 125°C
<b>Supply Voltage (<math>V_{DD}</math>)</b>		5.0V <sub>DC</sub> $\pm 10\%$
<b>Input Current</b>	250.000kHz to 24.000MHz	45mA Maximum
	24.001MHz to 50.000MHz	55mA Maximum
	50.001MHz to 66.667MHz	65mA Maximum
	66.668MHz to 106.250MHz	85mA Maximum
<b>Frequency Tolerance / Stability</b>	Inclusive of Operating Temperature Range, Supply Voltage, and Load	$\pm 100$ ppm, $\pm 50$ ppm, $\pm 25$ ppm, or $\pm 20$ ppm Max. (0°C to 70°C Only)
<b>Output Voltage Logic High (<math>V_{OH}</math>)</b>	w/TTL Load	2.4V <sub>DC</sub> Minimum
	w/HCMOS Load	$V_{DD} - 0.5V_{DC}$ Minimum
<b>Output Voltage Logic Low (<math>V_{OL}</math>)</b>	w/TTL Load	0.4V <sub>DC</sub> Maximum
	w/HCMOS Load	0.5V <sub>DC</sub> Maximum
<b>Rise Time / Fall Time</b>	0.4V <sub>DC</sub> to 2.4V <sub>DC</sub> w/TTL Load; 20% to 80% of Waveform w/HCMOS Load	6 nSeconds Maximum
<b>Duty Cycle</b>	at 1.4V <sub>DC</sub> w/TTL Load; at 50% of Waveform w/HCMOS Load	50 $\pm 10$ (%) (Standard)
	at 1.4V <sub>DC</sub> w/TTL Load or w/HCMOS Load $\leq 70.000$ MHz	50 $\pm 5$ (%) (Optional)
	at 50% of Waveform w/TTL Load or w/HCMOS Load $> 70.000$ MHz	50 $\pm 5$ (%) (Optional)
<b>Load Drive Capability</b>	250.000kHz to 24.000MHz	10TTL Load or 50pF HCMOS Load
	24.001MHz to 70.000MHz	10TTL Load or 15pF HCMOS Load
	70.001MHz to 106.250MHz	10LSTTL Load or 15pF HCMOS Load
<b>Tri-State Input Voltage</b>	$V_{IH}$ : No Connection	Enables Output
	$V_{IH}$ : $\geq 2.2V_{DC}$	Enables Output
	$V_{IL}$ : $\leq 0.8V_{DC}$	Disables Output: High Impedance
<b>Aging (at 25°C)</b>		$\pm 5$ ppm / year Maximum
<b>Start Up Time</b>		10mSeconds Maximum
<b>Period Jitter: Absolute</b>		$\pm 100$ pSeconds Maximum
<b>Period Jitter: One Sigma</b>		$\pm 25$ pSeconds Maximum

MANUFACTURER ECLIPTEK CORP.	CATEGORY OSCILLATOR	SERIES EC11	PACKAGE 8 pin DIP	VOLTAGE 5.0V	CLASS OS05	REV. DATE 08/06
--------------------------------	------------------------	----------------	----------------------	-----------------	---------------	--------------------

## PART NUMBERING GUIDE

### EC11 00 HS ETTS - 60.000M - G TR

#### FREQUENCY TOLERANCE / STABILITY

00=±100ppm Max. (Standard), 45=±50ppm Max.  
25=±25ppm Max., 20=±20ppm Max.

#### PACKAGE

HS=Half Size 8 Pin DIP

#### OPERATING TEMP. RANGE

Blank=0°C to 70°C (Standard), ET=-40°C to 85°C

#### DUTY CYCLE

Blank=50 ±10(%) (Standard), T=50 ±5(%)

#### OUTPUT CONTROL FUNCTION

Blank=None (No Connection on Pin 1), TS=Tri-State Enable High

#### PACKAGING OPTIONS

Blank=Bulk (Standard)  
TR=Tape & Reel (only offered with  
Half Size G and Half Size G2 Options)

#### AVAILABLE OPTIONS

Blank=None (Standard)  
CLXXX=Custom Lead Length (See Page 133)  
G=Half Size Gull Wing (See Page 132)  
G2=Half Size Gull Wing (See Page 132)

#### FREQUENCY

K=kHz, M=MHz

#### MECHANICAL DIMENSIONS ALL DIMENSIONS IN MILLIMETERS

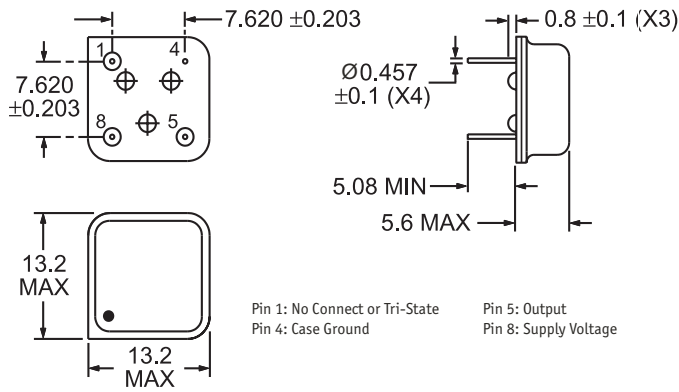

#### TAPE AND REEL DIMENSIONS ALL DIMENSIONS IN MILLIMETERS

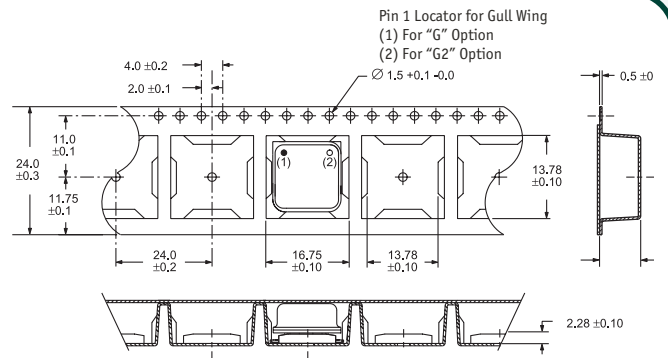

#### MARKING SPECIFICATIONS

Line 1: ECLIPTEK

Line 2: EC11 TS

Output Control Function  
Blank = None (No Connection on Pin 1)  
TS = Tri-State Enable High

Series Designator

Line 3: XX.XXX M

M=MHz, K=kHz

Frequency (5 Digits Maximum + Decimal)

Line 4: XX Y ZZ

Week of Year

Last Digit of Year

Ecliptek Manufacturing Identifier

Note: Pin 1 shall be designated with a dot

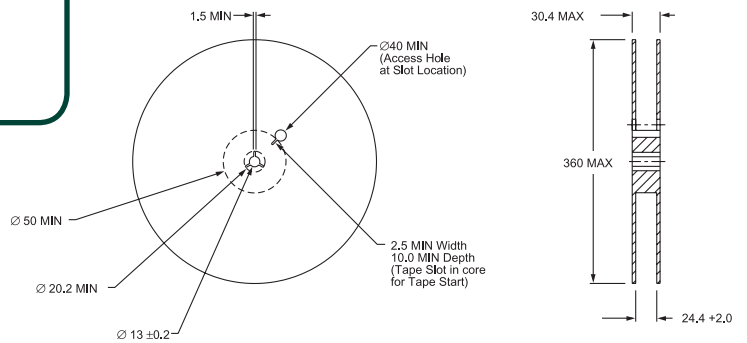

700 Pieces Per Reel  
Compliant to EIA-481A

#### ENVIRONMENTAL/MECHANICAL SPECIFICATIONS

Characteristic	Specification
Fine Leak Test	MIL-STD-883, Method 1014, Condition A
Gross Leak Test	MIL-STD-883, Method 1014, Condition C
Mechanical Shock	MIL-STD-202, Method 213, Condition C
Vibration	MIL-STD-883, Method 2007, Condition A
Lead Integrity	MIL-STD-883, Method 2004
Solderability	MIL-STD-883, Method 2002
Temperature Cycling	MIL-STD-883, Method 1010
Resistance to Soldering Heat	MIL-STD-883, Method 210
Resistance to Solvents	MIL-STD-883, Method 215

MANUFACTURER	CATEGORY	SERIES	PACKAGE	VOLTAGE	CLASS	REV. DATE
ECLIPTEK CORP.	OSCILLATOR	EC11	8 pin DIP	5.0V	OS05	08/06